









NTC3 REAR EXHAUST ENGINE INSTALLATION

			 1:1	 1:1	 1:1	TOOLS USED 5/64", 3/32"
2350, qty 1 rear exhaust manifold	7733, qty 1 silicone tubing	2353, qty 1 muffler	2353, qty 1 set screw	3216, qty 1 washer	6924, qty 1 4-40 x 3/8 screw	
						
3719, qty 2 wire tie, 6"		2358, qty 1 wire mount		2357, qty 1 manifold spring		

REAR EXHAUST ENGINE

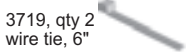
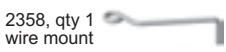
- 1 Attach the #2350 rear exhaust manifold to your engine with #2357 manifold spring--see two photos below.
- 2 Cut a piece of #7733 silicone tubing to 1 inch in length. Slide one end of the tubing about half way onto the muffler.
- 3 Slide the muffler with the tubing over the end of the manifold, making sure the manifold slides all the way into the muffler.
- 4 Slide the #2358 wire mount into the muffler and secure it with a #2353 set screw.
- 5 Attach the other end of the wire mount to the chassis brace with one #3216 washer and one #6924 screw.
- 6 Secure the silicone tubing with two #3719 wire ties.

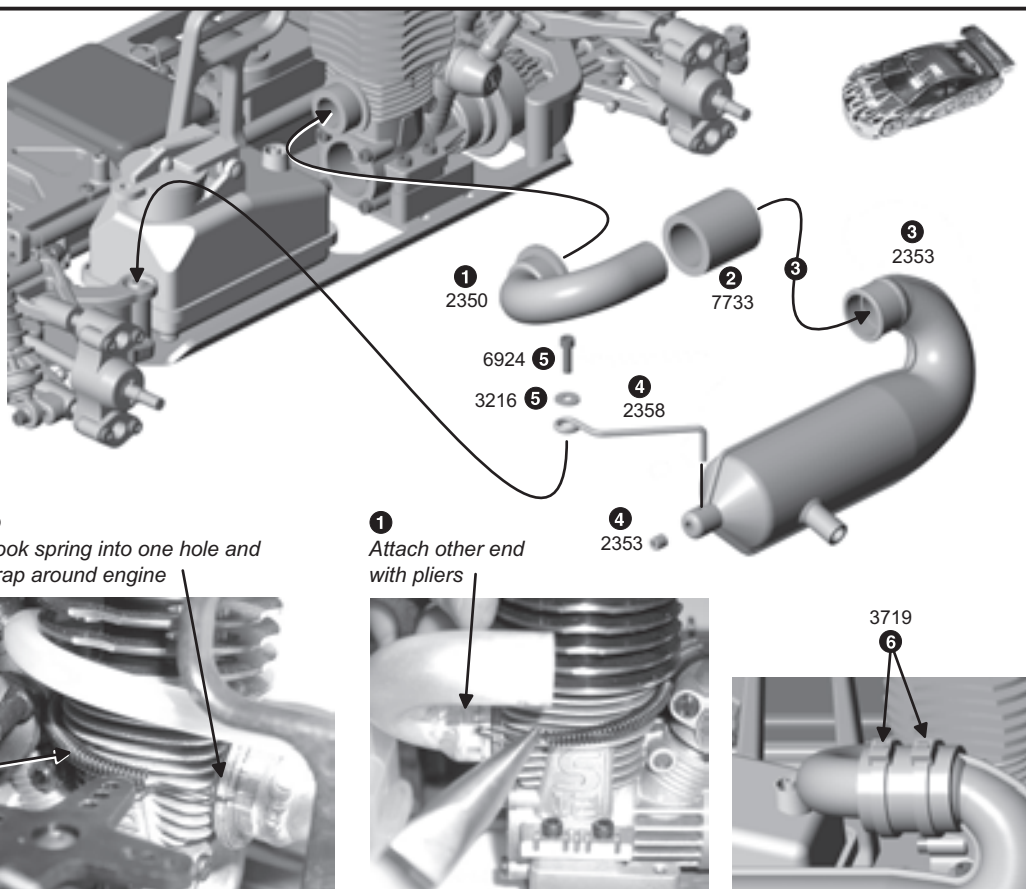

1 Hook spring into one hole and wrap around engine

1 Attach other end with pliers

These steps are found in the NTC3 instruction manual, page 24.

TEAM ASSOCIATED
3585 Cadillac Ave.
Costa Mesa, CA 92626



phone: (714) 850-9342
fax: (714) 850-1744
web site: <http://www.teamassociated.com>